



RIBAG

LIGHT
IN SHAPE.

Collection 15/16

SPINAled

Design Daniel Kübler / Erwin Egli





A line drawn in complete harmony.

SPINAled is the impressive result of the consistent development of the classic SPINA collection. Perfectly formed, to the most minor detail, it sets new standards for LED lighting technology, energy efficiency and design. Fitted with highly efficient LEDs, this light fitting brings extraordinary character, innovation and exclusivity to modern architecture.

















SPINAled

Mounted lamps

with acrylic glass diffuser, with dot matrix



- Mounting: Can be mounted on the wall or ceiling, with patented plug connection for easy to install lighting
- Lamp housing: Extruded anodised aluminium, with passive cooling
- Optics: Acrylic glass diffuser opal, with dot matrix
- Lamps: LED CRI 85, 2700K, 3000K or 4000K, integrated
- Service life: 50,000 hrs with 70% luminous flux
- Control gear: PS 230 V/50 Hz
- Lamp protection class: I
- Lamp protection level: IP 20
- Energy efficiency class A to A++, includes built-in LED lamps, unexchangeable lamps



Aluminium mat anodised

| Item No. | Watt | Lumen | Kelvin | Length |
|---------------|------|-------|--------|--------|
| 4001.060.27.0 | 9 | 1150 | 2700 | 600 |
| 4001.060.30.0 | 9 | 1200 | 3000 | 600 |
| 4001.060.40.0 | 9 | 1200 | 4000 | 600 |
| 4001.090.27.0 | 14 | 1750 | 2700 | 900 |
| 4001.090.30.0 | 14 | 1800 | 3000 | 900 |
| 4001.090.40.0 | 14 | 1800 | 4000 | 900 |
| 4001.120.27.0 | 18 | 2300 | 2700 | 1200 |
| 4001.120.30.0 | 18 | 2350 | 3000 | 1200 |
| 4001.120.40.0 | 18 | 2350 | 4000 | 1200 |
| 4001.150.27.0 | 22 | 2900 | 2700 | 1500 |
| 4001.150.30.0 | 22 | 2950 | 3000 | 1500 |
| 4001.150.40.0 | 22 | 2950 | 4000 | 1500 |

Aluminium mat anodised, dimmable DALI

| Item No. | Watt | Lumen | Kelvin | Length |
|-------------------|------|-------|--------|--------|
| 4001.060.27.0 DIG | 9 | 1150 | 2700 | 600 |
| 4001.060.30.0 DIG | 9 | 1200 | 3000 | 600 |
| 4001.060.40.0 DIG | 9 | 1200 | 4000 | 600 |
| 4001.090.27.0 DIG | 14 | 1750 | 2700 | 900 |
| 4001.090.30.0 DIG | 14 | 1800 | 3000 | 900 |
| 4001.090.40.0 DIG | 14 | 1800 | 4000 | 900 |
| 4001.120.27.0 DIG | 18 | 2300 | 2700 | 1200 |
| 4001.120.30.0 DIG | 18 | 2350 | 3000 | 1200 |
| 4001.120.40.0 DIG | 18 | 2350 | 4000 | 1200 |
| 4001.150.27.0 DIG | 22 | 2900 | 2700 | 1500 |
| 4001.150.30.0 DIG | 22 | 2950 | 3000 | 1500 |
| 4001.150.40.0 DIG | 22 | 2950 | 4000 | 1500 |



- Mounting: Can be mounted on the wall or ceiling, with patented plug connection for easy to install lighting
- Lamp housing: Extruded aluminium bright chrome finish, with passive cooling
- Optics: Acrylic glass diffuser opal, with dot matrix
- Lamps: LED CRI 85, 2700K, 3000K or 4000K, integrated
- Service life: 50,000 hrs with 70% luminous flux
- Control gear: PS 230 V/50 Hz
- Lamp protection class: I
- Lamp protection level: IP 20
- Energy efficiency class A to A++, includes built-in LED lamps, unexchangeable lamps



Aluminium bright chrome

| Item No. | Watt | Lumen | Kelvin | Length |
|---------------|------|-------|--------|--------|
| 4001.060.27.1 | 9 | 1150 | 2700 | 600 |
| 4001.060.30.1 | 9 | 1200 | 3000 | 600 |
| 4001.060.40.1 | 9 | 1200 | 4000 | 600 |
| 4001.090.27.1 | 14 | 1750 | 2700 | 900 |
| 4001.090.30.1 | 14 | 1800 | 3000 | 900 |
| 4001.090.40.1 | 14 | 1800 | 4000 | 900 |
| 4001.120.27.1 | 18 | 2300 | 2700 | 1200 |
| 4001.120.30.1 | 18 | 2350 | 3000 | 1200 |
| 4001.120.40.1 | 18 | 2350 | 4000 | 1200 |
| 4001.150.27.1 | 22 | 2900 | 2700 | 1500 |
| 4001.150.30.1 | 22 | 2950 | 3000 | 1500 |
| 4001.150.40.1 | 22 | 2950 | 4000 | 1500 |

Aluminium bright chrome, dimmable DALI

| Item No. | Watt | Lumen | Kelvin | Length |
|-------------------|------|-------|--------|--------|
| 4001.060.27.1 DIG | 9 | 1150 | 2700 | 600 |
| 4001.060.30.1 DIG | 9 | 1200 | 3000 | 600 |
| 4001.060.40.1 DIG | 9 | 1200 | 4000 | 600 |
| 4001.090.27.1 DIG | 14 | 1750 | 2700 | 900 |
| 4001.090.30.1 DIG | 14 | 1800 | 3000 | 900 |
| 4001.090.40.1 DIG | 14 | 1800 | 4000 | 900 |
| 4001.120.27.1 DIG | 18 | 2300 | 2700 | 1200 |
| 4001.120.30.1 DIG | 18 | 2350 | 3000 | 1200 |
| 4001.120.40.1 DIG | 18 | 2350 | 4000 | 1200 |
| 4001.150.27.1 DIG | 22 | 2900 | 2700 | 1500 |
| 4001.150.30.1 DIG | 22 | 2950 | 3000 | 1500 |
| 4001.150.40.1 DIG | 22 | 2950 | 4000 | 1500 |

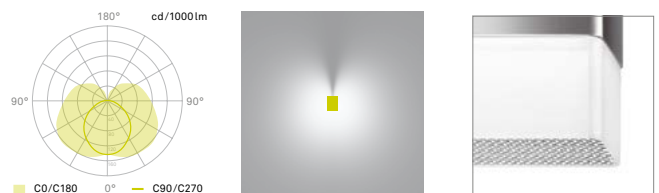
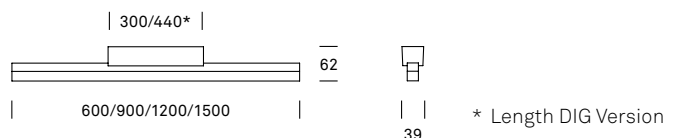
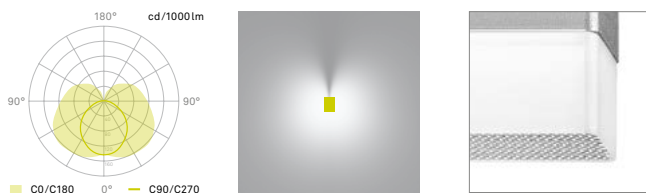
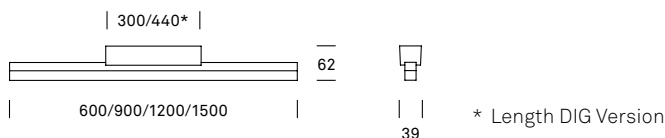

SPINAled

Mounted lamps

with linear lense clear /mat, Δ 60°



- Mounting: Can be mounted on the wall or ceiling, with patented plug connection for easy to install lighting
- Lamp housing: Extruded aluminium mat anodised, with passive cooling
- Optics: Linear lense, clear /mat, Δ 60°
- Lamps: LED CRI 85, 2700 K, 3000 K or 4000 K, integrated
- Service life: 50,000 hrs with 70% luminous flux
- Control gear: PS 230 V/50 Hz
- Lamp protection class: I
- Lamp protection level: IP 20
- Energy efficiency class A to A++, includes built-in LED lamps, unexchangeable lamps

LED

Aluminium mat anodised

| Item No. | Watt | Lumen | Kelvin | Length |
|---------------|------|-------|--------|--------|
| 4002.060.27.0 | 9 | 1150 | 2700 | 600 |
| 4002.060.30.0 | 9 | 1200 | 3000 | 600 |
| 4002.060.40.0 | 9 | 1200 | 4000 | 600 |
| 4002.090.27.0 | 14 | 1750 | 2700 | 900 |
| 4002.090.30.0 | 14 | 1800 | 3000 | 900 |
| 4002.090.40.0 | 14 | 1800 | 4000 | 900 |
| 4002.120.27.0 | 18 | 2300 | 2700 | 1200 |
| 4002.120.30.0 | 18 | 2350 | 3000 | 1200 |
| 4002.120.40.0 | 18 | 2350 | 4000 | 1200 |
| 4002.150.27.0 | 22 | 2900 | 2700 | 1500 |
| 4002.150.30.0 | 22 | 2950 | 3000 | 1500 |
| 4002.150.40.0 | 22 | 2950 | 4000 | 1500 |

Aluminium mat anodised, dimmable DALI

| Item No. | Watt | Lumen | Kelvin | Length |
|-------------------|------|-------|--------|--------|
| 4002.060.27.0 DIG | 9 | 1150 | 2700 | 600 |
| 4002.060.30.0 DIG | 9 | 1200 | 3000 | 600 |
| 4002.060.40.0 DIG | 9 | 1200 | 4000 | 600 |
| 4002.090.27.0 DIG | 14 | 1750 | 2700 | 900 |
| 4002.090.30.0 DIG | 14 | 1800 | 3000 | 900 |
| 4002.090.40.0 DIG | 14 | 1800 | 4000 | 900 |
| 4002.120.27.0 DIG | 18 | 2300 | 2700 | 1200 |
| 4002.120.30.0 DIG | 18 | 2350 | 3000 | 1200 |
| 4002.120.40.0 DIG | 18 | 2350 | 4000 | 1200 |
| 4002.150.27.0 DIG | 22 | 2900 | 2700 | 1500 |
| 4002.150.30.0 DIG | 22 | 2950 | 3000 | 1500 |
| 4002.150.40.0 DIG | 22 | 2950 | 4000 | 1500 |

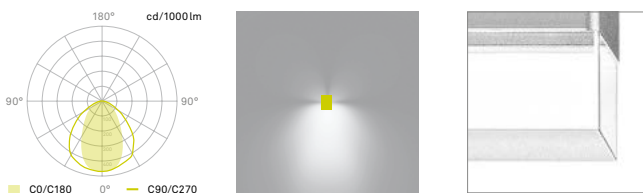
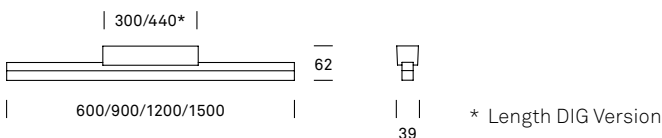

Mounted lamps

with wall washer 25°



- Mounting: Can be mounted on the wall or ceiling, with patented plug connection for easy to install lighting
- Lamp housing: Extruded aluminium mat anodised, with passive cooling
- Optics: Acrylic glass diffuser, fine mat, asymmetrical reflector, 25° to the vertical
- Lamps: LED CRI 85, 2700 K, 3000 K or 4000 K, integrated
- Service life: 50,000 hrs with 70% luminous flux
- Control gear: PS 230 V/50 Hz
- Lamp protection class: I
- Lamp protection level: IP 20
- Energy efficiency class A to A++, includes built-in LED lamps, unexchangeable lamps

LED MINERGIE®

Aluminium mat anodised

| Item No. | Watt | Lumen | Kelvin | Length |
|---------------|------|-------|--------|--------|
| 4003.060.27.0 | 9 | 1150 | 2700 | 600 |
| 4003.060.30.0 | 9 | 1200 | 3000 | 600 |
| 4003.060.40.0 | 9 | 1200 | 4000 | 600 |
| 4003.090.27.0 | 14 | 1750 | 2700 | 900 |
| 4003.090.30.0 | 14 | 1800 | 3000 | 900 |
| 4003.090.40.0 | 14 | 1800 | 4000 | 900 |
| 4003.120.27.0 | 18 | 2300 | 2700 | 1200 |
| 4003.120.30.0 | 18 | 2350 | 3000 | 1200 |
| 4003.120.40.0 | 18 | 2350 | 4000 | 1200 |
| 4003.150.27.0 | 22 | 2900 | 2700 | 1500 |
| 4003.150.30.0 | 22 | 2950 | 3000 | 1500 |
| 4003.150.40.0 | 22 | 2950 | 4000 | 1500 |

Aluminium mat anodised, dimmable DALI

| Item No. | Watt | Lumen | Kelvin | Length |
|-------------------|------|-------|--------|--------|
| 4003.060.27.0 DIG | 9 | 1150 | 2700 | 600 |
| 4003.060.30.0 DIG | 9 | 1200 | 3000 | 600 |
| 4003.060.40.0 DIG | 9 | 1200 | 4000 | 600 |
| 4003.090.27.0 DIG | 14 | 1750 | 2700 | 900 |
| 4003.090.30.0 DIG | 14 | 1800 | 3000 | 900 |
| 4003.090.40.0 DIG | 14 | 1800 | 4000 | 900 |
| 4003.120.27.0 DIG | 18 | 2300 | 2700 | 1200 |
| 4003.120.30.0 DIG | 18 | 2350 | 3000 | 1200 |
| 4003.120.40.0 DIG | 18 | 2350 | 4000 | 1200 |
| 4003.150.27.0 DIG | 22 | 2900 | 2700 | 1500 |
| 4003.150.30.0 DIG | 22 | 2950 | 3000 | 1500 |
| 4003.150.40.0 DIG | 22 | 2950 | 4000 | 1500 |

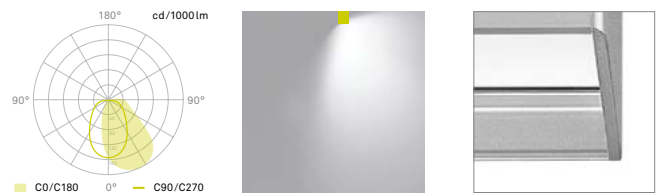
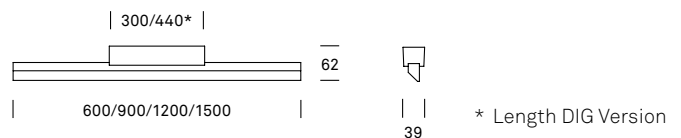

SPINAled

Mounted lamps

with wall washer 90°



- Mounting: Can be mounted on the wall or ceiling, with patented plug connection for easy to install lighting
- Lamp housing: Extruded aluminium mat anodised, with passive cooling
- Optics: Acrylic glass diffuser, fine mat, asymmetrical reflector, 90° to the horizontal
- Lamps: LED CRI 85, 2700 K, 3000 K or 4000 K, integrated
- Service life: 50,000 hrs with 70% luminous flux
- Control gear: PS 230 V/50 Hz
- Lamp protection class: I
- Lamp protection level: IP 20
- Energy efficiency class A to A++, includes built-in LED lamps, unexchangeable lamps



Aluminium mat anodised

| Item No. | Watt | Lumen | Kelvin | Length |
|---------------|------|-------|--------|--------|
| 4004.060.27.0 | 9 | 1150 | 2700 | 600 |
| 4004.060.30.0 | 9 | 1200 | 3000 | 600 |
| 4004.060.40.0 | 9 | 1200 | 4000 | 600 |
| 4004.090.27.0 | 14 | 1750 | 2700 | 900 |
| 4004.090.30.0 | 14 | 1800 | 3000 | 900 |
| 4004.090.40.0 | 14 | 1800 | 4000 | 900 |
| 4004.120.27.0 | 18 | 2300 | 2700 | 1200 |
| 4004.120.30.0 | 18 | 2350 | 3000 | 1200 |
| 4004.120.40.0 | 18 | 2350 | 4000 | 1200 |
| 4004.150.27.0 | 22 | 2900 | 2700 | 1500 |
| 4004.150.30.0 | 22 | 2950 | 3000 | 1500 |
| 4004.150.40.0 | 22 | 2950 | 4000 | 1500 |

Aluminium mat anodised, dimmable DALI

| Item No. | Watt | Lumen | Kelvin | Length |
|-------------------|------|-------|--------|--------|
| 4004.060.27.0 DIG | 9 | 1150 | 2700 | 600 |
| 4004.060.30.0 DIG | 9 | 1200 | 3000 | 600 |
| 4004.060.40.0 DIG | 9 | 1200 | 4000 | 600 |
| 4004.090.27.0 DIG | 14 | 1750 | 2700 | 900 |
| 4004.090.30.0 DIG | 14 | 1800 | 3000 | 900 |
| 4004.090.40.0 DIG | 14 | 1800 | 4000 | 900 |
| 4004.120.27.0 DIG | 18 | 2300 | 2700 | 1200 |
| 4004.120.30.0 DIG | 18 | 2350 | 3000 | 1200 |
| 4004.120.40.0 DIG | 18 | 2350 | 4000 | 1200 |
| 4004.150.27.0 DIG | 22 | 2900 | 2700 | 1500 |
| 4004.150.30.0 DIG | 22 | 2950 | 3000 | 1500 |
| 4004.150.40.0 DIG | 22 | 2950 | 4000 | 1500 |

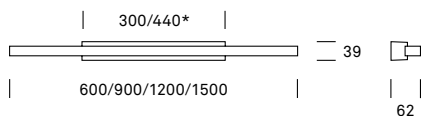

* Length DIG Version

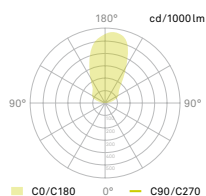

SPINAled

Pendant lamps

with acrylic glass diffuser



- Mounting: For mounting on the ceiling, 2 nickel-plated steel-cable suspensions, length 2500 mm, continuously adjustable height, 2 cable holders, transparent cable 2 x 0.35 mm²
- Lamp housing: Extruded aluminium mat anodised, with passive cooling
- Optics: Acrylic glass diffuser, opal
- Lamps: LED CRI 85, 2700 K, 3000 K or 4000 K, integrated
- Service life: 50,000 hrs with 70% luminous flux
- Control gear: PS 230 V/50 Hz (in a separate housing)
- Lamp protection class: I
- Lamp protection level: IP 20
- Energy efficiency class A to A++, includes built-in LED lamps, unexchangeable lamps

LED MINERGIE®

Aluminium mat anodised

| Item No. | Watt | Lumen | Kelvin | Length |
|---------------|------|-------|--------|--------|
| 4010.090.27.0 | 14 | 1750 | 2700 | 900 |
| 4010.090.30.0 | 14 | 1800 | 3000 | 900 |
| 4010.090.40.0 | 14 | 1800 | 4000 | 900 |
| 4010.120.27.0 | 18 | 2300 | 2700 | 1200 |
| 4010.120.30.0 | 18 | 2350 | 3000 | 1200 |
| 4010.120.40.0 | 18 | 2350 | 4000 | 1200 |
| 4010.150.27.0 | 22 | 2900 | 2700 | 1500 |
| 4010.150.30.0 | 22 | 2950 | 3000 | 1500 |
| 4010.150.40.0 | 22 | 2950 | 4000 | 1500 |

Aluminium mat anodised, dimmable DALI

| Item No. | Watt | Lumen | Kelvin | Length |
|-------------------|------|-------|--------|--------|
| 4010.090.27.0 DIG | 14 | 1750 | 2700 | 900 |
| 4010.090.30.0 DIG | 14 | 1800 | 3000 | 900 |
| 4010.090.40.0 DIG | 14 | 1800 | 4000 | 900 |
| 4010.120.27.0 DIG | 18 | 2300 | 2700 | 1200 |
| 4010.120.30.0 DIG | 18 | 2350 | 3000 | 1200 |
| 4010.120.40.0 DIG | 18 | 2350 | 4000 | 1200 |
| 4010.150.27.0 DIG | 22 | 2900 | 2700 | 1500 |
| 4010.150.30.0 DIG | 22 | 2950 | 3000 | 1500 |
| 4010.150.40.0 DIG | 22 | 2950 | 4000 | 1500 |

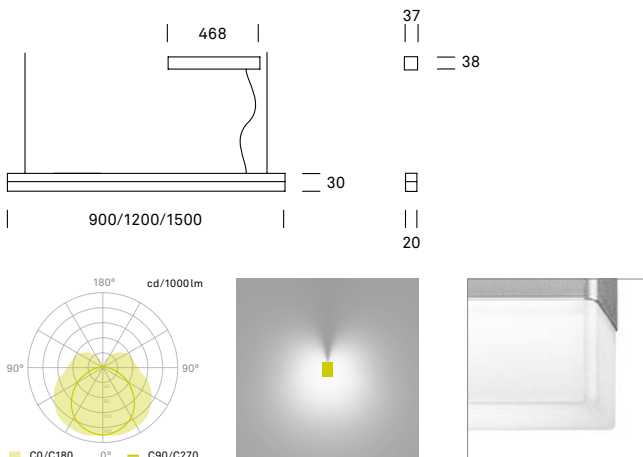

Pendant lamps

with acrylic glass diffuser, with dot matrix



- Mounting: For mounting on the ceiling, 2 nickel-plated steel-cable suspensions, length 2500mm, continuously adjustable height, 2 cable holders, transparent cable 2 x 0.35 mm²
- Lamp housing: Extruded aluminium mat anodised, with passive cooling
- Optics: Acrylic glass diffuser, opal with dot matrix
- Lamps: LED CRI 85, 2700 K, 3000 K or 4000 K, integrated
- Service life: 50,000 hrs with 70% luminous flux
- Control gear: PS 230 V/50 Hz (in a separate housing)
- Lamp protection class: I
- Lamp protection level: IP 20
- Energy efficiency class A to A++, includes built-in LED lamps, unexchangeable lamps

LED

Aluminium mat anodised

| Item No. | Watt | Lumen | Kelvin | Length |
|---------------|------|-------|--------|--------|
| 4011.090.27.0 | 14 | 1750 | 2700 | 900 |
| 4011.090.30.0 | 14 | 1800 | 3000 | 900 |
| 4011.090.40.0 | 14 | 1800 | 4000 | 900 |
| 4011.120.27.0 | 18 | 2300 | 2700 | 1200 |
| 4011.120.30.0 | 18 | 2350 | 3000 | 1200 |
| 4011.120.40.0 | 18 | 2350 | 4000 | 1200 |
| 4011.150.27.0 | 22 | 2900 | 2700 | 1500 |
| 4011.150.30.0 | 22 | 2950 | 3000 | 1500 |
| 4011.150.40.0 | 22 | 2950 | 4000 | 1500 |

Aluminium mat anodised, dimmable DALI

| Item No. | Watt | Lumen | Kelvin | Length |
|-------------------|------|-------|--------|--------|
| 4011.090.27.0 DIG | 14 | 1750 | 2700 | 900 |
| 4011.090.30.0 DIG | 14 | 1800 | 3000 | 900 |
| 4011.090.40.0 DIG | 14 | 1800 | 4000 | 900 |
| 4011.120.27.0 DIG | 18 | 2300 | 2700 | 1200 |
| 4011.120.30.0 DIG | 18 | 2350 | 3000 | 1200 |
| 4011.120.40.0 DIG | 18 | 2350 | 4000 | 1200 |
| 4011.150.27.0 DIG | 22 | 2900 | 2700 | 1500 |
| 4011.150.30.0 DIG | 22 | 2950 | 3000 | 1500 |
| 4011.150.40.0 DIG | 22 | 2950 | 4000 | 1500 |

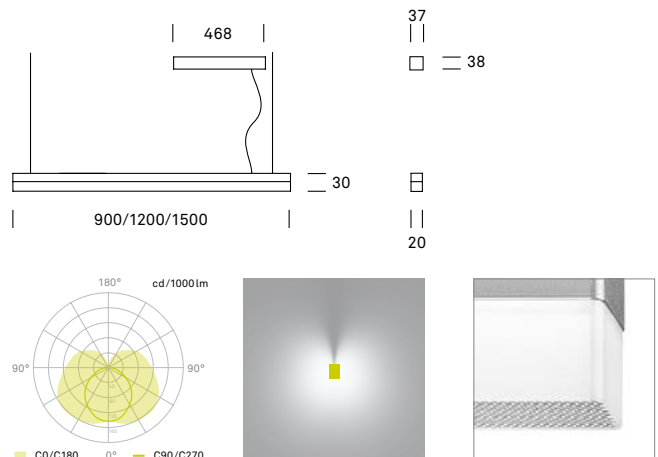

SPINAled

Pendant lamps

with linear lense clear/mat, $\Delta 60^\circ$



- Mounting: For mounting on the ceiling, 2 nickel-plated steel-cable suspensions, length 2500mm, continuously adjustable height, 2 cable holders, transparent cable $2 \times 0.35 \text{ mm}^2$
- Lamp housing: Extruded aluminium mat anodised, with passive cooling
- Optics: Linear lense, clear/mat, $\Delta 60^\circ$
- Lamps: LED CRI 85, 2700 K, 3000 K or 4000 K, integrated
- Service life: 50,000 hrs with 70% luminous flux
- Control gear: PS 230 V/50 Hz (in a separate housing)
- Lamp protection class: I
- Lamp protection level: IP 20
- Energy efficiency class A to A++, includes built-in LED lamps, unexchangeable lamps



Aluminium mat anodised

| Item No. | Watt | Lumen | Kelvin | Length |
|---------------|------|-------|--------|--------|
| 4012.090.27.0 | 14 | 1750 | 2700 | 900 |
| 4012.090.30.0 | 14 | 1800 | 3000 | 900 |
| 4012.090.40.0 | 14 | 1800 | 4000 | 900 |
| 4012.120.27.0 | 18 | 2300 | 2700 | 1200 |
| 4012.120.30.0 | 18 | 2350 | 3000 | 1200 |
| 4012.120.40.0 | 18 | 2350 | 4000 | 1200 |
| 4012.150.27.0 | 22 | 2900 | 2700 | 1500 |
| 4012.150.30.0 | 22 | 2950 | 3000 | 1500 |
| 4012.150.40.0 | 22 | 2950 | 4000 | 1500 |

Aluminium mat anodised, dimmable DALI

| Item No. | Watt | Lumen | Kelvin | Length |
|-------------------|------|-------|--------|--------|
| 4012.090.27.0 DIG | 14 | 1750 | 2700 | 900 |
| 4012.090.30.0 DIG | 14 | 1800 | 3000 | 900 |
| 4012.090.40.0 DIG | 14 | 1800 | 4000 | 900 |
| 4012.120.27.0 DIG | 18 | 2300 | 2700 | 1200 |
| 4012.120.30.0 DIG | 18 | 2350 | 3000 | 1200 |
| 4012.120.40.0 DIG | 18 | 2350 | 4000 | 1200 |
| 4012.150.27.0 DIG | 22 | 2900 | 2700 | 1500 |
| 4012.150.30.0 DIG | 22 | 2950 | 3000 | 1500 |
| 4012.150.40.0 DIG | 22 | 2950 | 4000 | 1500 |

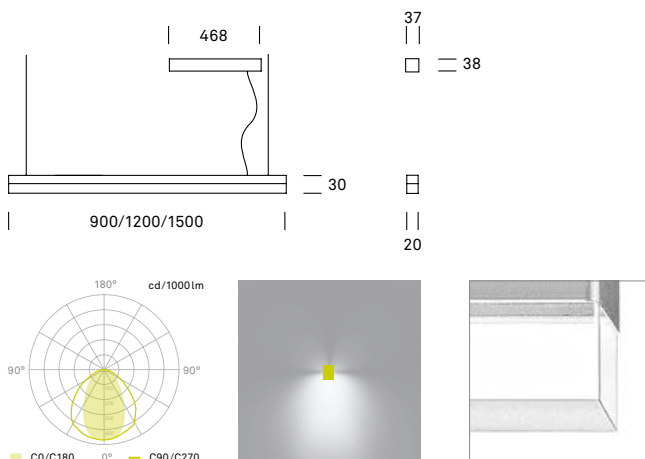

- Mounting: For mounting on the ceiling, 2 nickel-plated copper cables, transparently sheathed, length 2500mm, continuously adjustable height
- Lamp housing: Extruded aluminium high-gloss chrome plating, with passive cooling
- Optics: Linear lense, clear/mat, $\Delta 60^\circ$
- Lamps: LED CRI 85, 2700 K, 3000 K or 4000 K, integrated
- Service life: 50,000 hrs with 70% luminous flux
- Control gear: 230 V/50 Hz (in a separate housing)
- Lamp protection class: I
- Lamp protection level: IP 20
- Energy efficiency class A to A++, includes built-in LED lamps, unexchangeable lamps



Aluminium bright chrome

| Item No. | Watt | Lumen | Kelvin | Length |
|---------------|------|-------|--------|--------|
| 4012.120.27.1 | 18 | 2300 | 2700 | 1200 |
| 4012.120.30.1 | 18 | 2350 | 3000 | 1200 |
| 4012.120.40.1 | 18 | 2350 | 4000 | 1200 |
| 4012.150.27.1 | 22 | 2900 | 2700 | 1500 |
| 4012.150.30.1 | 22 | 2950 | 3000 | 1500 |
| 4012.150.40.1 | 22 | 2950 | 4000 | 1500 |

Aluminium bright chrome, dimmable DALI

| Item No. | Watt | Lumen | Kelvin | Length |
|-------------------|------|-------|--------|--------|
| 4012.120.27.1 DIG | 18 | 2300 | 2700 | 1200 |
| 4012.120.30.1 DIG | 18 | 2350 | 3000 | 1200 |
| 4012.120.40.1 DIG | 18 | 2350 | 4000 | 1200 |
| 4012.150.27.1 DIG | 22 | 2900 | 2700 | 1500 |
| 4012.150.30.1 DIG | 22 | 2950 | 3000 | 1500 |
| 4012.150.40.1 DIG | 22 | 2950 | 4000 | 1500 |

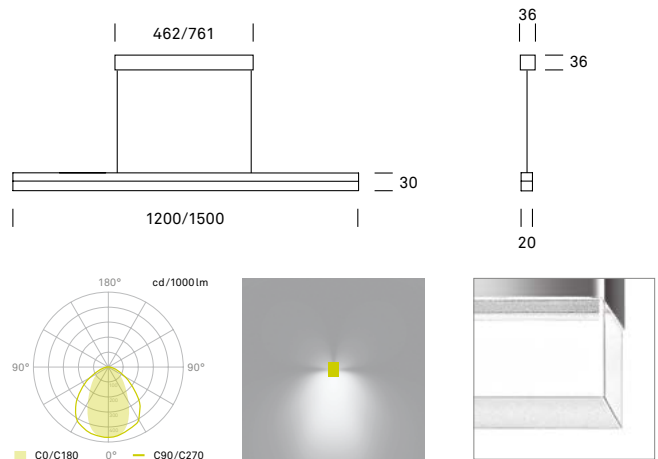

SPINAled

Pendant lamps

with wall washer 25°



- Mounting: For mounting on the ceiling, 2 nickel-plated steel-cable suspensions, length 2500 mm, continuously adjustable height, 2 cable holders, transparent cable 2 × 0.35 mm²
- Lamp housing: Extruded aluminium mat anodised, with passive cooling
- Optics: Acrylic glass diffuser, fine mat, asymmetrical reflector, 25° to the vertical
- Lamps: LED CRI 85, 2700 K, 3000 K or 4000 K, integrated
- Service life: 50,000 hrs with 70% luminous flux
- Control gear: PS 230 V/50 Hz (in a separate housing)
- Lamp protection class: I
- Lamp protection level: IP 20
- Energy efficiency class A to A++, includes built-in LED lamps, unexchangeable lamps

LED MINERGIE®

Aluminium mat anodised

| Item No. | Watt | Lumen | Kelvin | Length |
|---------------|------|-------|--------|--------|
| 4013.090.27.0 | 14 | 1750 | 2700 | 900 |
| 4013.090.30.0 | 14 | 1800 | 3000 | 900 |
| 4013.090.40.0 | 14 | 1800 | 4000 | 900 |
| 4013.120.27.0 | 18 | 2300 | 2700 | 1200 |
| 4013.120.30.0 | 18 | 2350 | 3000 | 1200 |
| 4013.120.40.0 | 18 | 2350 | 4000 | 1200 |
| 4013.150.27.0 | 22 | 2900 | 2700 | 1500 |
| 4013.150.30.0 | 22 | 2950 | 3000 | 1500 |
| 4013.150.40.0 | 22 | 2950 | 4000 | 1500 |

Aluminium mat anodised, dimmable DALI

| Item No. | Watt | Lumen | Kelvin | Length |
|-------------------|------|-------|--------|--------|
| 4013.090.27.0 DIG | 14 | 1750 | 2700 | 900 |
| 4013.090.30.0 DIG | 14 | 1800 | 3000 | 900 |
| 4013.090.40.0 DIG | 14 | 1800 | 4000 | 900 |
| 4013.120.27.0 DIG | 18 | 2300 | 2700 | 1200 |
| 4013.120.30.0 DIG | 18 | 2350 | 3000 | 1200 |
| 4013.120.40.0 DIG | 18 | 2350 | 4000 | 1200 |
| 4013.150.27.0 DIG | 22 | 2900 | 2700 | 1500 |
| 4013.150.30.0 DIG | 22 | 2950 | 3000 | 1500 |
| 4013.150.40.0 DIG | 22 | 2950 | 4000 | 1500 |

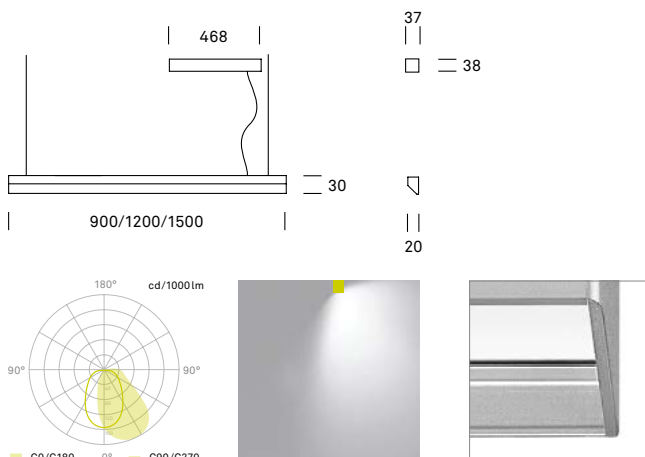

SPINAled

Mounted elements without control gear

with acrylic glass diffuser, opal



- Mounting: Can be mounted on the wall or ceiling, for indoor or outdoor use (protected from rain)
- Function: Can be mounted in series with an intermediate connection or connecting profiles (order separately)
- Lamp housing: Extruded aluminium mat anodised, with passive cooling
- Optics: Acrylic glass diffuser, opal
- Lamps: LED CRI 85, 2700 K, 3000 K or 4000 K, integrated
- Service life: 50,000 hrs with 70% luminous flux
- Control gear: PS 230 V/50 Hz, constant current 500 mA (order separately)
- Lamp protection class: III
- Lamp protection level: IP 54
- Energy efficiency class A to A++, includes built-in LED lamps, unexchangeable lamps

LED MINERGIE®

Aluminium mat anodised

| Item No. | Watt | Lumen | Kelvin | Length |
|---------------|------|-------|--------|--------|
| 4020.060.27.0 | 9 | 1150 | 2700 | 600 |
| 4020.060.30.0 | 9 | 1200 | 3000 | 600 |
| 4020.060.40.0 | 9 | 1200 | 4000 | 600 |
| 4020.090.27.0 | 14 | 1750 | 2700 | 900 |
| 4020.090.30.0 | 14 | 1800 | 3000 | 900 |
| 4020.090.40.0 | 14 | 1800 | 4000 | 900 |
| 4020.120.27.0 | 18 | 2300 | 2700 | 1200 |
| 4020.120.30.0 | 18 | 2350 | 3000 | 1200 |
| 4020.120.40.0 | 18 | 2350 | 4000 | 1200 |
| 4020.150.27.0 | 22 | 2900 | 2700 | 1500 |
| 4020.150.30.0 | 22 | 2950 | 3000 | 1500 |
| 4020.150.40.0 | 22 | 2950 | 4000 | 1500 |



- Mounting: Can be mounted on the wall or ceiling, for indoor or outdoor use (protected from rain)
- Function: Can be mounted in series with an intermediate connection or connecting profiles (order separately)
- Lamp housing: Extruded aluminium high-gloss chrome plating, with passive cooling
- Optics: Acrylic glass diffuser, opal
- Lamps: LED CRI 85, 2700 K, 3000 K or 4000 K, integrated
- Service life: 50,000 hrs with 70% luminous flux
- Control gear: PS 230 V/50 Hz, constant current 500 mA (order separately)
- Lamp protection class: III
- Lamp protection level: IP 54
- Energy efficiency class A to A++, includes built-in LED lamps, unexchangeable lamps

LED MINERGIE®

Aluminium bright chrome

| Item No. | Watt | Lumen | Kelvin | Length |
|---------------|------|-------|--------|--------|
| 4020.060.27.1 | 9 | 1150 | 2700 | 600 |
| 4020.060.30.1 | 9 | 1200 | 3000 | 600 |
| 4020.060.40.1 | 9 | 1200 | 4000 | 600 |
| 4020.090.27.1 | 14 | 1750 | 2700 | 900 |
| 4020.090.30.1 | 14 | 1800 | 3000 | 900 |
| 4020.090.40.1 | 14 | 1800 | 4000 | 900 |
| 4020.120.27.1 | 18 | 2300 | 2700 | 1200 |
| 4020.120.30.1 | 18 | 2350 | 3000 | 1200 |
| 4020.120.40.1 | 18 | 2350 | 4000 | 1200 |
| 4020.150.27.1 | 22 | 2900 | 2700 | 1500 |
| 4020.150.30.1 | 22 | 2950 | 3000 | 1500 |
| 4020.150.40.1 | 22 | 2950 | 4000 | 1500 |

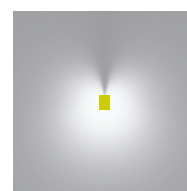
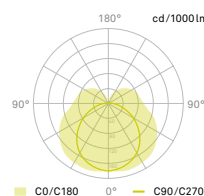
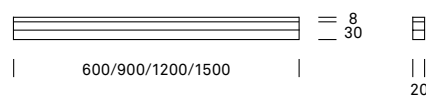
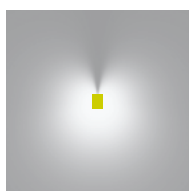
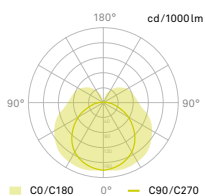
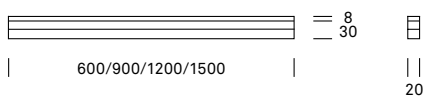

SPINAled

Mounted elements without control gear

with acrylic diffuser opal, with dot matrix



- Mounting: Can be mounted on the wall or ceiling, for indoor or outdoor use (protected from rain)
- Function: Can be mounted in series with an intermediate connection or connecting profiles (order separately)
- Lamp housing: Extruded aluminium mat anodised, with passive cooling
- Optics: Acrylic glass diffuser, opal with dot matrix
- Lamps: LED CRI 85, 2700 K, 3000 K or 4000 K, integrated
- Service life: 50,000 hrs with 70% luminous flux
- Control gear: PS 230 V/50 Hz, constant current 500 mA (order separately)
- Lamp protection class: III
- Lamp protection level: IP 54
- Energy efficiency class A to A++, includes built-in LED lamps, unexchangeable lamps



Aluminium mat anodised

| Item No. | Watt | Lumen | Kelvin | Length |
|---------------|------|-------|--------|--------|
| 4021.060.27.0 | 9 | 1150 | 2700 | 600 |
| 4021.060.30.0 | 9 | 1200 | 3000 | 600 |
| 4021.060.40.0 | 9 | 1200 | 4000 | 600 |
| 4021.090.27.0 | 14 | 1750 | 2700 | 900 |
| 4021.090.30.0 | 14 | 1800 | 3000 | 900 |
| 4021.090.40.0 | 14 | 1800 | 4000 | 900 |
| 4021.120.27.0 | 18 | 2300 | 2700 | 1200 |
| 4021.120.30.0 | 18 | 2350 | 3000 | 1200 |
| 4021.120.40.0 | 18 | 2350 | 4000 | 1200 |
| 4021.150.27.0 | 22 | 2900 | 2700 | 1500 |
| 4021.150.30.0 | 22 | 2950 | 3000 | 1500 |
| 4021.150.40.0 | 22 | 2950 | 4000 | 1500 |



- Mounting: Can be mounted on the wall or ceiling, for indoor or outdoor use (protected from rain)
- Function: Can be mounted in series with an intermediate connection or connecting profiles (order separately)
- Lamp housing: Extruded aluminium high-gloss chrome plating, with passive cooling
- Optics: Acrylic glass diffuser, opal with dot matrix
- Lamps: LED CRI 85, 2700 K, 3000 K or 4000 K, integrated
- Service life: 50,000 hrs with 70% luminous flux
- Control gear: PS 230 V/50 Hz, constant current 500 mA (order separately)
- Lamp protection class: III
- Lamp protection level: IP 54
- Energy efficiency class A to A++, includes built-in LED lamps, unexchangeable lamps



Aluminium bright chrome

| Item No. | Watt | Lumen | Kelvin | Length |
|---------------|------|-------|--------|--------|
| 4021.060.27.1 | 9 | 1150 | 2700 | 600 |
| 4021.060.30.1 | 9 | 1200 | 3000 | 600 |
| 4021.060.40.1 | 9 | 1200 | 4000 | 600 |
| 4021.090.27.1 | 14 | 1750 | 2700 | 900 |
| 4021.090.30.1 | 14 | 1800 | 3000 | 900 |
| 4021.090.40.1 | 14 | 1800 | 4000 | 900 |
| 4021.120.27.1 | 18 | 2300 | 2700 | 1200 |
| 4021.120.30.1 | 18 | 2350 | 3000 | 1200 |
| 4021.120.40.1 | 18 | 2350 | 4000 | 1200 |
| 4021.150.27.1 | 22 | 2900 | 2700 | 1500 |
| 4021.150.30.1 | 22 | 2950 | 3000 | 1500 |
| 4021.150.40.1 | 22 | 2950 | 4000 | 1500 |

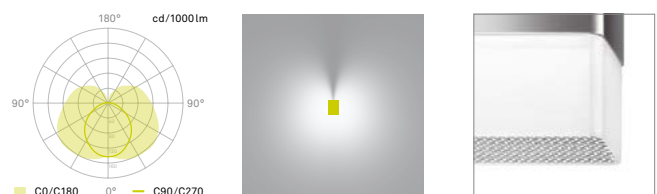
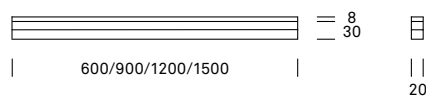
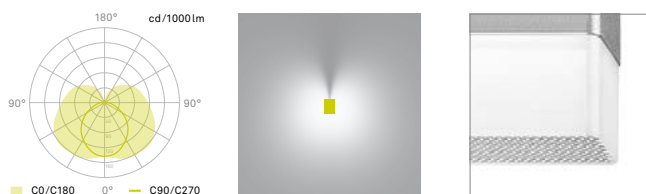
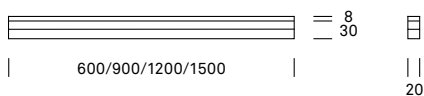

SPINAled

Mounted elements without control gear

with linear lense clear/mat, $\Delta 60^\circ$



- Mounting: Can be mounted on the wall or ceiling, for indoor or outdoor use (protected from rain)
- Function: Can be mounted in series with an intermediate connection or connecting profiles (order separately)
- Lamp housing: Extruded aluminium mat anodised, with passive cooling
- Optics: Linear lense, clear/mat, $\Delta 60^\circ$
- Lamps: LED CRI 85, 2700K, 3000K or 4000K, integrated
- Service life: 50,000 hrs with 70% luminous flux
- Control gear: PS 230 V/50 Hz, constant current 500 mA (order separately)
- Lamp protection class: III
- Lamp protection level: IP 54
- Energy efficiency class A to A++, includes built-in LED lamps, unexchangeable lamps



Aluminium mat anodised

| Item No. | Watt | Lumen | Kelvin | Length |
|---------------|------|-------|--------|--------|
| 4022.060.27.0 | 9 | 1150 | 2700 | 600 |
| 4022.060.30.0 | 9 | 1200 | 3000 | 600 |
| 4022.060.40.0 | 9 | 1200 | 4000 | 600 |
| 4022.090.27.0 | 14 | 1750 | 2700 | 900 |
| 4022.090.30.0 | 14 | 1800 | 3000 | 900 |
| 4022.090.40.0 | 14 | 1800 | 4000 | 900 |
| 4022.120.27.0 | 18 | 2300 | 2700 | 1200 |
| 4022.120.30.0 | 18 | 2350 | 3000 | 1200 |
| 4022.120.40.0 | 18 | 2350 | 4000 | 1200 |
| 4022.150.27.0 | 22 | 2900 | 2700 | 1500 |
| 4022.150.30.0 | 22 | 2950 | 3000 | 1500 |
| 4022.150.40.0 | 22 | 2950 | 4000 | 1500 |

Mounted elements without control gear

with wall washer 25°



- Mounting: Can be mounted on the wall or ceiling, for indoor or outdoor use (protected from rain)
- Function: Can be mounted in series with an intermediate connection or connecting profiles (order separately)
- Lamp housing: Extruded aluminium mat anodised, with passive cooling
- Optics: Acrylic glass diffuser, fine mat, asymmetrical reflector, 25° to the vertical
- Lamps: LED CRI 85, 2700K, 3000K or 4000K, integrated
- Service life: 50,000 hrs with 70% luminous flux
- Control gear: PS 230 V/50 Hz, constant current 500 mA (order separately)
- Lamp protection class: III
- Lamp protection level: IP 54
- Energy efficiency class A to A++, includes built-in LED lamps, unexchangeable lamps



Aluminium mat anodised

| Item No. | Watt | Lumen | Kelvin | Length |
|---------------|------|-------|--------|--------|
| 4023.060.27.0 | 14 | 1750 | 2700 | 600 |
| 4023.060.30.0 | 14 | 1800 | 3000 | 600 |
| 4023.060.40.0 | 14 | 1800 | 4000 | 600 |
| 4023.090.27.0 | 18 | 2300 | 2700 | 900 |
| 4023.090.30.0 | 18 | 2350 | 3000 | 900 |
| 4023.090.40.0 | 18 | 2350 | 4000 | 900 |
| 4023.120.27.0 | 22 | 2900 | 2700 | 1200 |
| 4023.120.30.0 | 22 | 2950 | 3000 | 1200 |
| 4023.120.40.0 | 22 | 2950 | 4000 | 1200 |
| 4023.150.27.0 | 34 | 3535 | 2700 | 1500 |
| 4023.150.30.0 | 34 | 3535 | 3000 | 1500 |
| 4023.150.40.0 | 34 | 3535 | 4000 | 1500 |

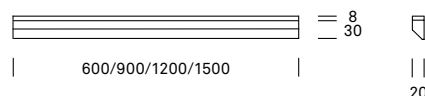
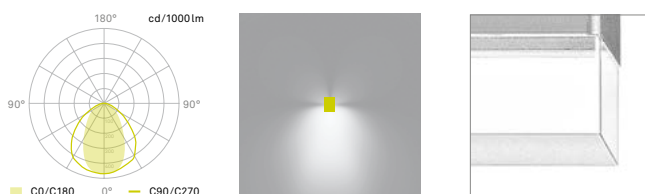
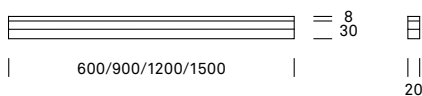

SPINAled

Mounted elements without control gear

with wall washer 90°



- Mounting: Can be mounted on the wall or ceiling, for indoor or outdoor use (protected from rain)
- Function: Can be mounted in series with an intermediate connection or connecting profiles (order separately)
- Lamp housing: Extruded aluminium mat anodised, with passive cooling
- Optics: Acrylic glass diffuser, fine mat, asymmetrical reflector, 90° to the horizontal
- Lamps: LED CRI 85, 2700 K, 3000 K or 4000 K, integrated
- Service life: 50,000 hrs with 70% luminous flux
- Control gear: PS 230 V/50 Hz, constant current 500 mA (order separately)
- Lamp protection class: III
- Lamp protection level: IP 54
- Energy efficiency class A to A++, includes built-in LED lamps, unexchangeable lamps

LED

Aluminium mat anodised

| Item No. | Watt | Lumen | Kelvin | Length |
|---------------|------|-------|--------|--------|
| 4024.060.27.0 | 14 | 1750 | 2700 | 600 |
| 4024.060.30.0 | 14 | 1800 | 3000 | 600 |
| 4024.060.40.0 | 14 | 1800 | 4000 | 600 |
| 4024.090.27.0 | 18 | 2300 | 2700 | 900 |
| 4024.090.30.0 | 18 | 2350 | 3000 | 900 |
| 4024.090.40.0 | 18 | 2350 | 4000 | 900 |
| 4024.120.27.0 | 22 | 2900 | 2700 | 1200 |
| 4024.120.30.0 | 22 | 2950 | 3000 | 1200 |
| 4024.120.40.0 | 22 | 2950 | 4000 | 1200 |
| 4024.150.27.0 | 34 | 3535 | 2700 | 1500 |
| 4024.150.30.0 | 34 | 3535 | 3000 | 1500 |
| 4024.150.40.0 | 34 | 3535 | 4000 | 1500 |

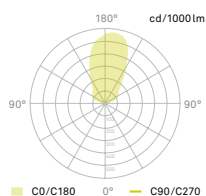
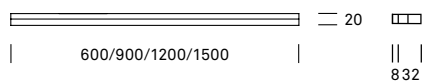

SPINAled

Operating equipment and accessories for the add-on elements

Operating devices

- Operating devices 230 V/50–60 Hz, 500 mA
- Short circuit and overload protected

| Item No. | Watt | Dimmable | Dim. in mm |
|-----------------|------|---|---------------|
| 915.012.500 | 12 | No | 115 × 34 × 19 |
| 915.024.500 | 24 | No | 103 × 67 × 21 |
| 915.035.500 | 35 | No | 125 × 79 × 22 |
| 915.024.500 DIG | 24 | TouchDIM ¹ 1–10 V ² DALI ³ | 103 × 67 × 21 |
| 915.035.500 DIG | 35 | TouchDIM ¹ 1–10 V ² DALI ³ | 125 × 79 × 22 |

Legend

- ¹ Control with TouchDim button
- ² Control with 1–10V dimmer
- ³ Control with DALI-light regulator

Connection profile

| Item No. | Length |
|------------|--------|
| 4020.060.0 | 600 |
| 4020.090.0 | 900 |
| 4020.120.0 | 1200 |
| 4020.150.0 | 1500 |
| 4020.180.0 | 1800 |

Distributor terminal

- For connecting 2–6 lights to 1 operating device
- Size 64 × 26 × 15 mm

| Item No. | Colour |
|-----------|--------|
| 919.006.0 | |

Intermediate connector

| Item No. | Colour |
|------------|---------------|
| 4020.000.0 | Metallic grey |
| 4020.000.1 | Chrome |



PLANNING NOTES

Maximum number of lamps per operating device

| Item No. | 600 mm | 900 mm | 1200 mm | 1500 mm |
|-----------------|--------|--------|---------|---------|
| 915.012.500 | 1 | – | – | – |
| 915.024.500 | 1–2 | 1 | 1 | – |
| 915.035.500 | 1–3 | 1–2 | 1 | 1 |
| 915.024.500 DIG | 1–2 | 1 | 1 | – |
| 915.035.500 DIG | 1–3 | 1–2 | 1 | 1 |

Connection diagram with an external LED converter

Individual light

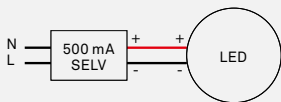

Maximum of 6 lights with the distributor terminal (item No. 919.006.0)

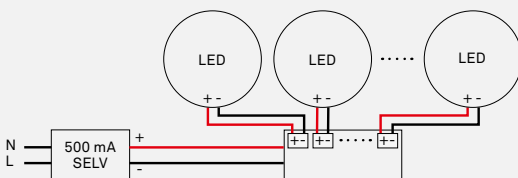

Several lights without a distributor terminal

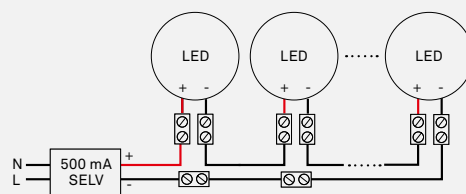

Never connect the lights in parallel

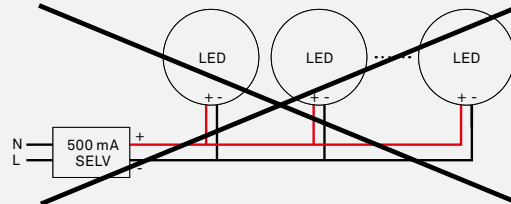

We recommend that you regulate the brightness of the light with a DALI dimmer from a specialized electrical retailer for a secure operation outside of the DALI lighting system (e.g. Feller, Osram, Jung, Gira).

For information on the lumens and wattage refer to the bulb manufacturer's specifications. You can find out the photometrically calculated luminous flux in the technical light data (LDT) ready for download on our website.

There may be very narrow colour tolerances with LEDs. However, these are reduced to a minimum (<3 MacAdam).

RIBAG

ribag.com

Art. 961.019.15